

# Intro to Packaged Plumbing and Mechanical Systems

Conrad Jahrling  
Product Manager at Lync by Watts

2022 IAPMO EWTS

### Individual Water Heaters, Boilers

- Heat exchanger
- Tank or Tankless
- Part of a multi-component DHW System

### Custom Packaged Water Heating Skids

- Pre-designed system
- Off-site build
- Components acquired & assembled by independent packagers

### PPMS



Single Source Design & Assembly Assurance



Auditable quality system



Smart and Connected



# Trends and problems being addressed

## Improved safety

- Controlled off-site environment
- Factory-level quality control program

## Tight labor market

- Skilled labor pipeline issue
- Labor shifted to other activities
- Parallel, off-site construction

## Single point of accountability

- Single relationship
- “For want of a nail...”
- Shifted liability

## Increased efficiencies

- Minimized footprint
- Volume purchasing
- Pre-testing
- Single shipment

## Smart and Connected

- Controls labor minimized
- Potential BAS and SCADA pre-configuration

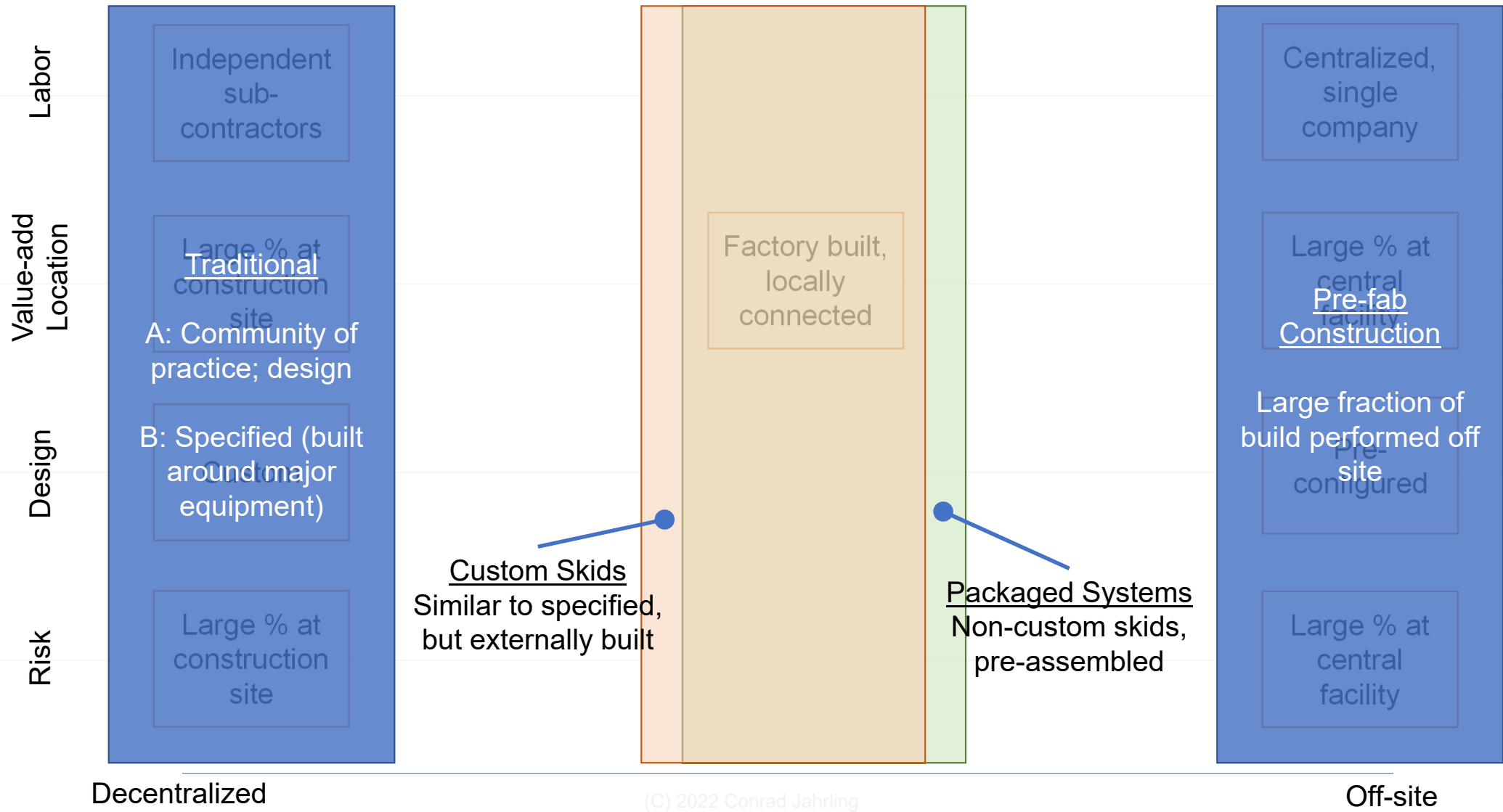

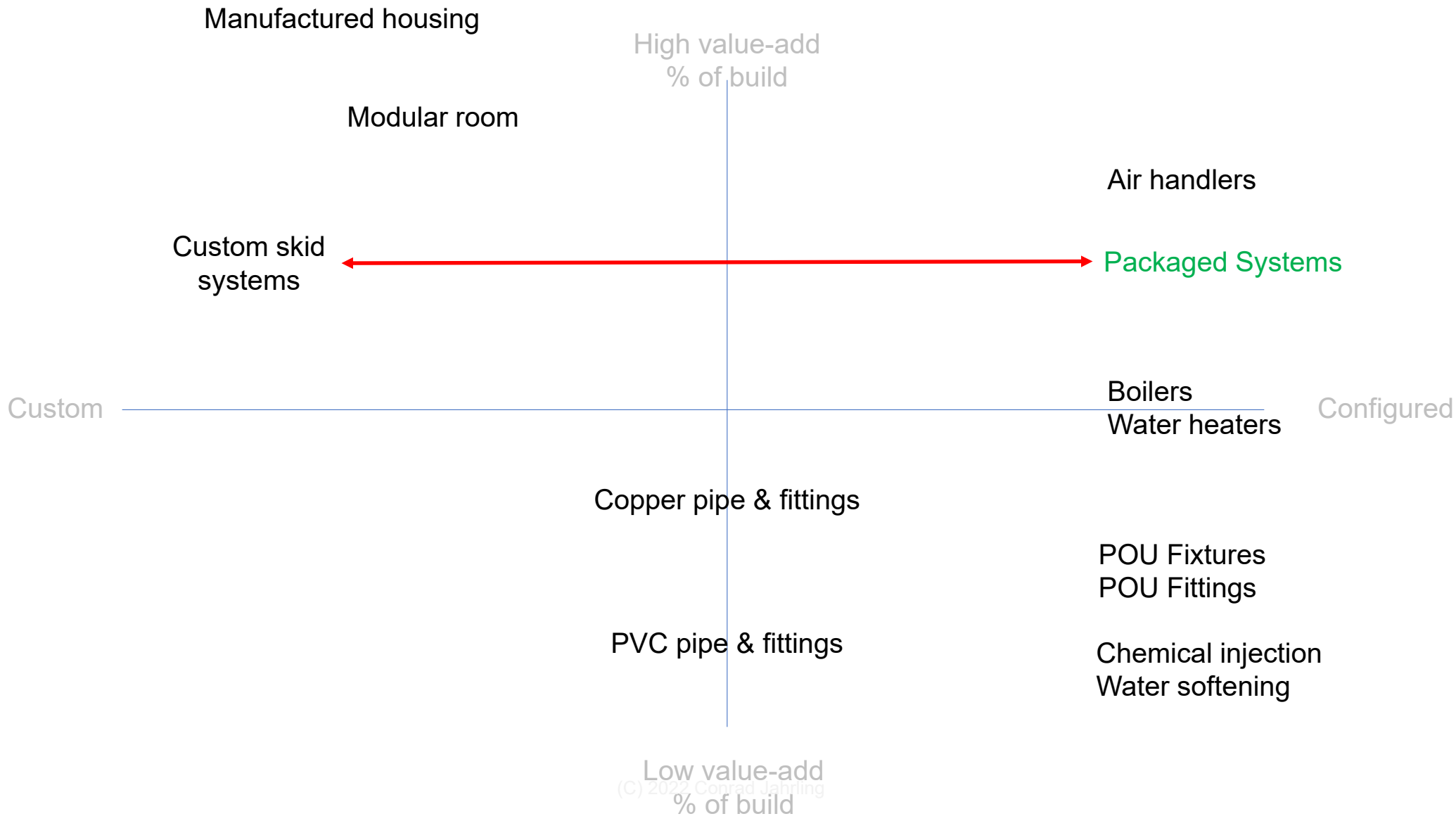

# Added Benefits of Factory-built PPMS

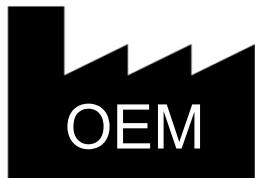

Controlled quality system

Standardized designs

- 3<sup>rd</sup>-party certified (if a standard exists)

Warranty on build and subsystems

Potential aaS pricing

Depth of subsystem knowledge

Expanded controls sequence algorithms

# PPMS Examples

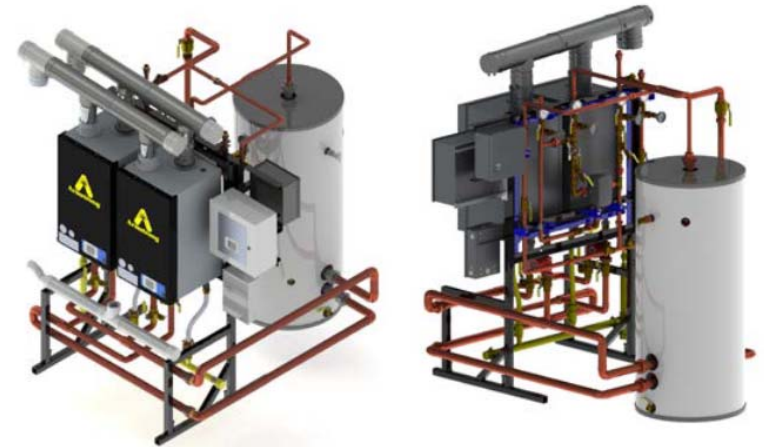

(C) 2022 Conrad Jahrling

# Trade-offs with packaged systems

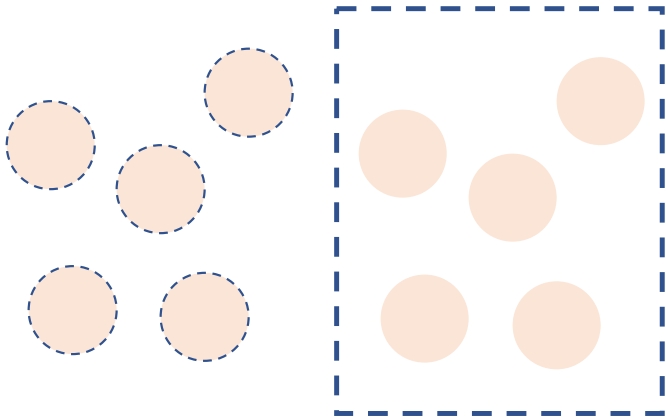

Lack of customization means designing around available designs.

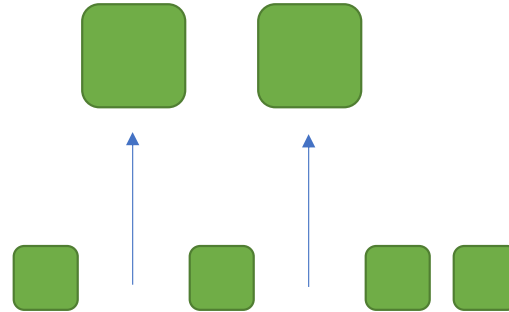

New category means few firms make packaged systems today

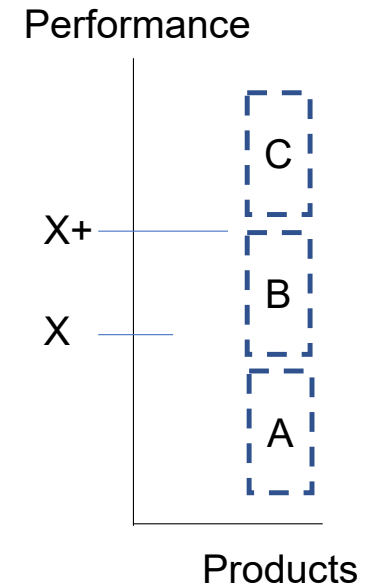

Potentially too much safety factor for need



# Opportunities

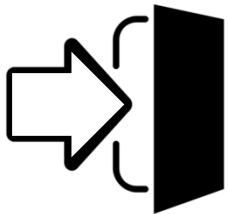

If the footprint can move **through a doorway**:

- During new construction of pushing equipment install to after the walls and doors are up
- For retrofit, you can move equipment through a building without opening walls



If the PPMS comes with a **local supervisory controller**:

- Minimize BAS integration time & cost by having several subsystems and components already connected
- Some allow for mobile app connectivity

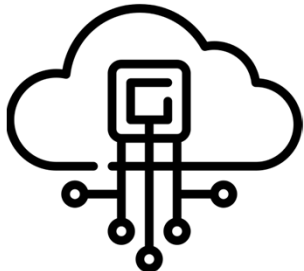

If using an **aaS financial model**:

- Shift from capital to variable costs
- Post-Covid trend in building design is moving to flexible use

# Comparative Costs<sup>1</sup>

What are you saving on?

- Equipment design
- Controls programming and labor
- Footprint utilization
- Piping connection labor between equipment

What is cost-prohibitive for traditional systems?

- Central maintenance notifications
- Mobile app
- Custom equipment processes
- 3<sup>rd</sup>-party certification

Scenario:

- 198-bed healthcare facility
- 1.33M gal of hot water used

Equipment, qty 2:

- 1MM BTU/hr water heaters
- Master mixing valves
- (2) filters
- (2) UV systems
- Booster pump
- T&P transducers
- TAC anti-scale system
- Solenoid, isolation valves
- Local supervisory controller

	Design (\$150/hr)	Controls	Footprint (\$315/sqft leased space)	Installation (# of connections)
<b>“Traditional”</b>	130-200hrs	5-15 points	225 sqft	134
<b>Packaged system</b>	0	>90 points	59 sqft	24
<b>Cost savings</b>	\$20-30k	\$30-50k	\$52k/yr	\$105k

<sup>1</sup> A full analysis can be reviewed upon request (C) 2022 Conrad Jahrling

# Regulatory Relationship

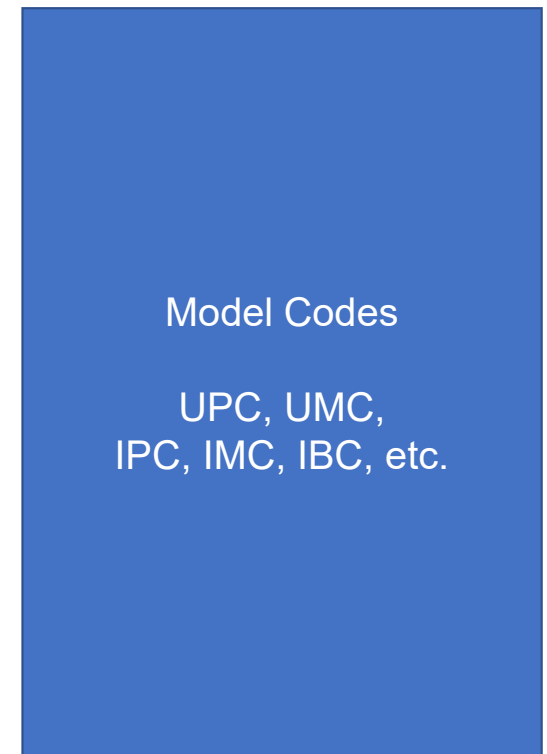
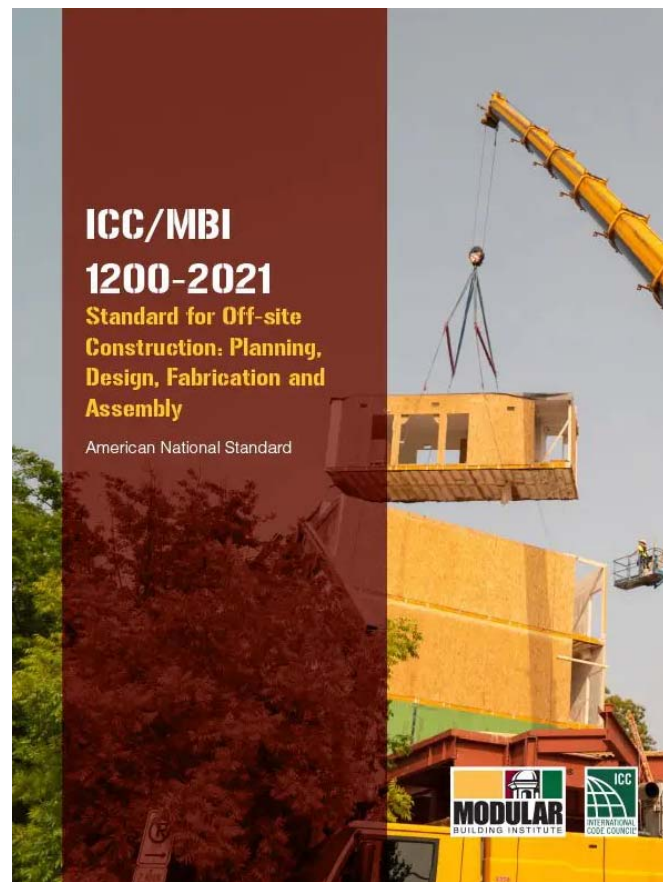
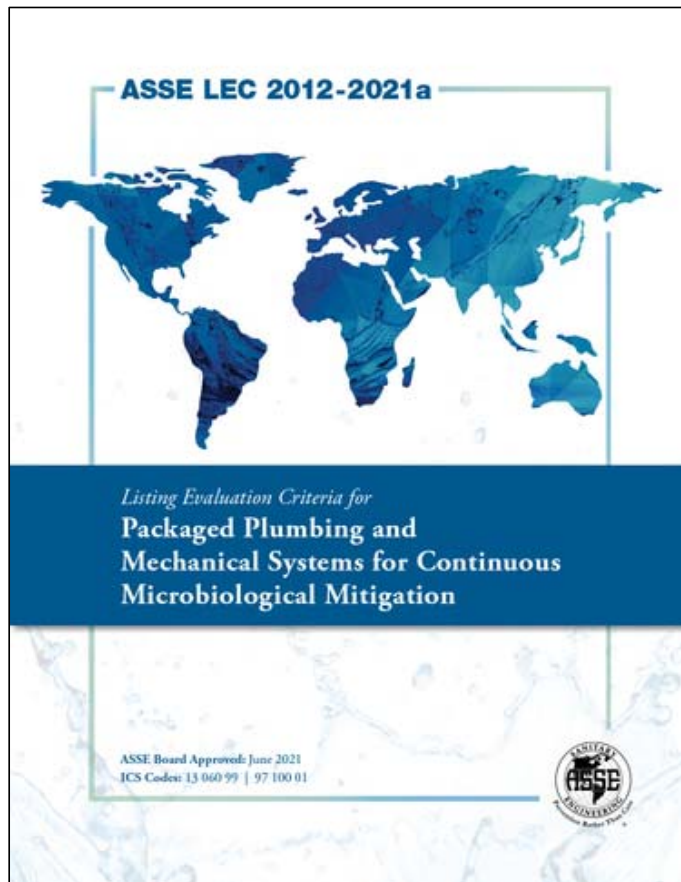

# Thank you

Conrad Jahrling

Product Manager at Lync by Watts

[conrad.jahrling@wattswater.com](mailto:conrad.jahrling@wattswater.com)

